

TILE & TILE SHOWER OPTIONS

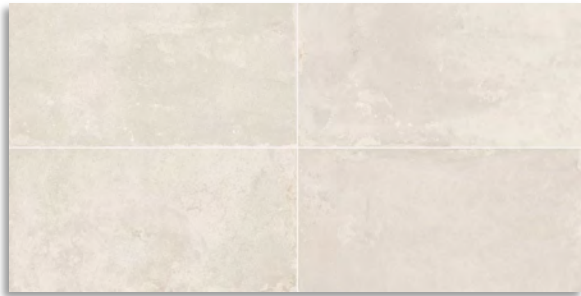

TILE OPTIONS

12x24 CERAMIC FLOOR/WALL TILE



Urbanize — White

Thickness: 5/16"

Grout Spacing: 1/8"

Suggested Grout: #386 Oyster Gray

Price Level: \$



Urbanize — Beige

Thickness: 5/16"

Grout Spacing: 1/8"

Suggested Grout: #172 Urban Putty

Price Level: \$



Urbanize — Grey

Thickness: 5/16"

Grout Spacing: 1/8"

Suggested Grout: #165 Delorean Gray

Price Level: \$

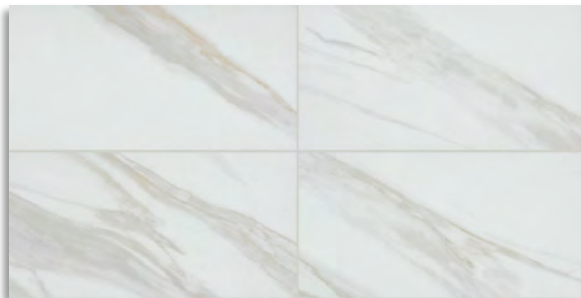

CoStar — Timeless Marble

Thickness: 5/16"

Grout Spacing: 1/8"

Suggested Grout: #381 Bright White

Price Level: \$

Final selection should be made by physical samples

TILE OPTIONS

12x24 PORCELAIN FLOOR/WALL TILE



Rhyme—Stone Chamber
Thickness: 9mm
Grout Spacing: 1/8"
Suggested Grout: #335 Winter Gray
Price Level:\$ \$

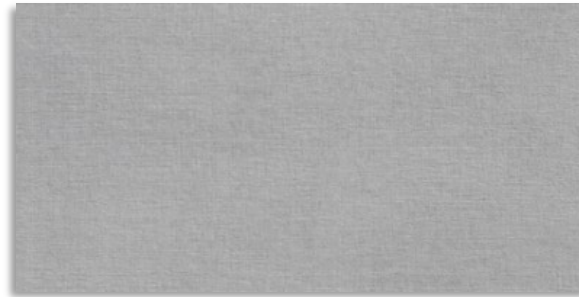

Rhyme—Silver Melody
Thickness: 9mm
Grout Spacing: 1/8"
Suggested Grout: #165 Delorean Gray
Price Level:\$ \$



Rhyme—Ivory Staccato
Thickness: 9mm
Grout Spacing: 1/8"
Suggested Grout: #381 Bright White
Price Level:\$ \$



Ironcraft—Phosphor White
Thickness: 5/16"
Grout Spacing: 1/8"
Suggested Grout: #386 Oyster Gray
Price Level:\$ \$ \$ \$



Ironcraft—Sable Black
Thickness: 5/16"
Grout Spacing: 1/8"
Suggested Grout: #540 Truffle
Price Level:\$ \$ \$ \$



Ironcraft—Charcoal Grey
Thickness: 5/16"
Grout Spacing: 1/8"
Suggested Grout: #335 Winter Gray
Price Level:\$ \$ \$ \$

Final selection should be made by physical samples

TILE OPTIONS

12x24 PORCELAIN FLOOR/WALL TILE



Enchant—Charm

Thickness: 10mm

Grout Spacing: 1/8"

Suggested Grout: #335 Winter Gray

Price Level: \$\$\$



Modtique—Loft Deco

Thickness: 10mm

Grout Spacing: 1/8"

Suggested Grout: #335 Winter Gray

Price Level: \$\$\$\$



Modtique—Salon Deco

Thickness: 10mm

Grout Spacing: 1/8"

Suggested Grout: #19 Pewter

Price Level: \$\$\$\$



Florentine—Carrara

Thickness: 5/16"

Grout Spacing: 1/8"

Suggested Grout: #381 Bright White

Price Level: \$



Enlarged section of Modtique—Loft Deco



Enlarged section of Modtique—Loft Deco

Final selection should be made by physical samples

TILE OPTIONS

12x12 CERAMIC FLOOR/WALL/BACKSPLASH TILE



Memoir— Petal Gray

Thickness: 5/16"

Grout Spacing: 3/16"

Suggested Grout: #381 Bright White

Price Level: \$\$



Memoir— Petal Black (Shown)

Thickness: 5/16"

Grout Spacing: 3/16"

Suggested Grout: #381 Bright White

Price Level: \$\$



Final selection should be made by physical samples

TILE OPTIONS

BACK SPLASH OPTION



3x12 Emotive—Bravado Black Silk
Matte Finish
Thickness: 5/16"
Grout Spacing: 1/8"
Suggested Grout: #19 Pewter
Price Level: \$\$\$\$



3x12 Emotive – Coy Grey Silk
Matte Finish
Thickness: 5/16"
Grout Spacing: 1/8"
Suggested Grout: #381 Bright White
Price Level: \$\$\$\$



3x12 Emotive—Astonished White Silk
Matte Finish
Thickness: 8.5mm
Grout Spacing: 1/8"
Suggested Grout: #165 Delorean Gray
Price Level: \$\$\$\$



1x3 Color Wheel—White Herringbone
#790 Matte Finish
Thickness: 5/16"
Grout Spacing: 3/16"
Suggested Grout: #165 Delorean Gray
Price Level: \$\$\$\$

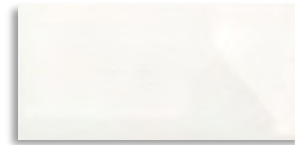

3x6 Color Wheel—Arctic White
#190 Gloss Finish
Thickness: 5/16"
Grout Spacing: 1/16"
Suggested Grout: #386 Oyster Gray
Price Level: \$\$\$\$

Final selection should be made by physical samples

TILE SHOWER OPTIONS

IRONCRAFT WALK-IN TILE SHOWER



IC17—GREY BLACK

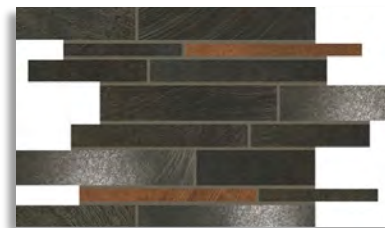

IC18—SABLE BRONZE

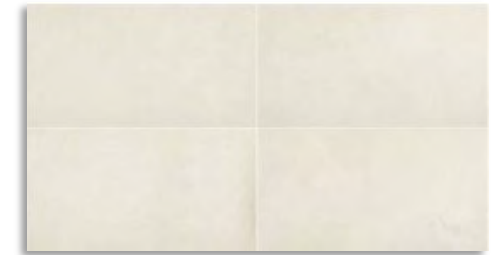

IC11— PHOSPER WHITE
Grout: 382 Bone

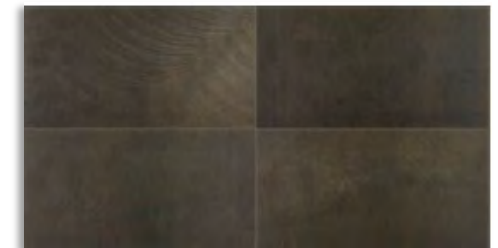

IC15—SABLE BLACK
Grout: 165 Delorean Gray

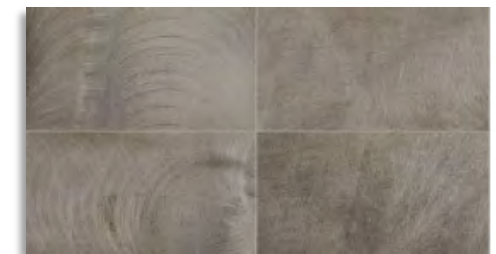

IC13—CHARCOAL GREY
Grout: Winter Gray

Final selection should be made by physical samples

TILE SHOWER OPTIONS

IRONCRAFT WALK-IN TILE SHOWER PLAN

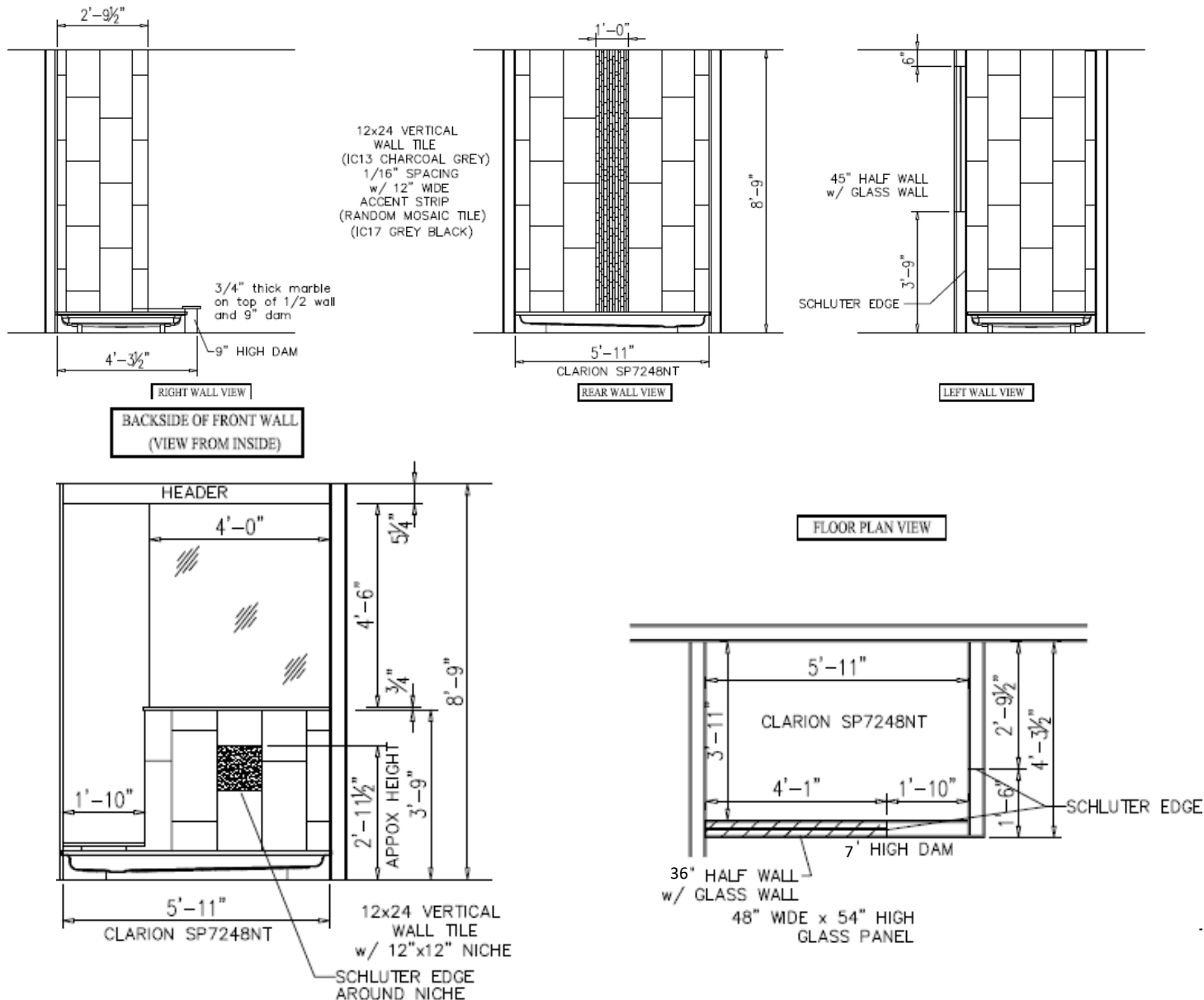

TILE SHOWER OPTIONS

IRONCRAFT 60" VERTICAL TILE SHOWER



Shower shown with Optional Barn Shower Door



IC17—GREY BLACK

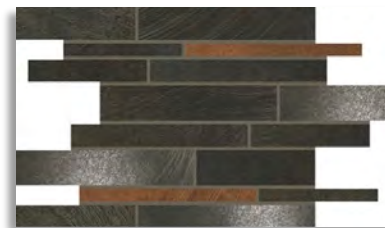

IC18—SABLE BRONZE

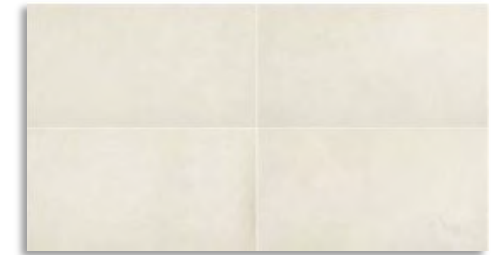

IC11— PHOSPER WHITE
Grout: 382 Bone

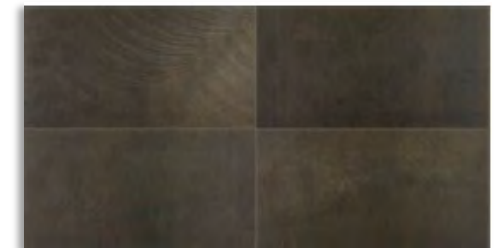

IC15—SABLE BLACK
Grout: 165 Delorean Gray

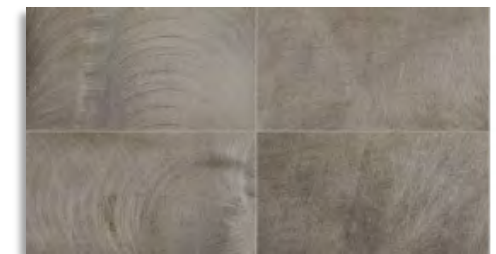

IC13—CHARCOAL GREY
Grout: Winter Gray

Final selection should be made by physical samples

TILE SHOWER OPTIONS

IRONCRAFT 60" VERTICAL SHOWER PLAN

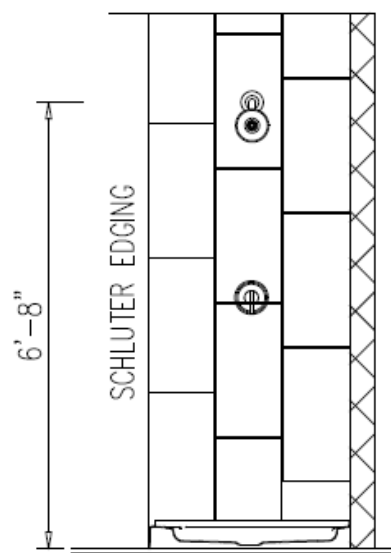
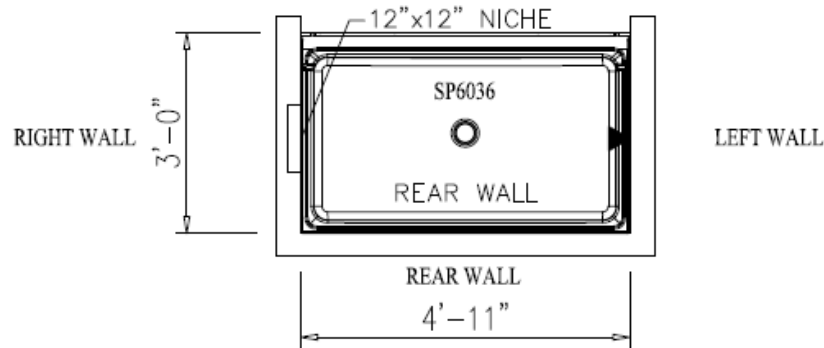

LEFT WALL

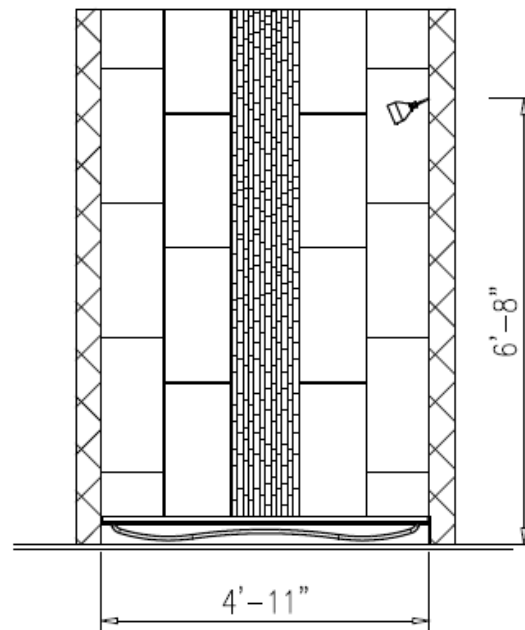

REAR WALL

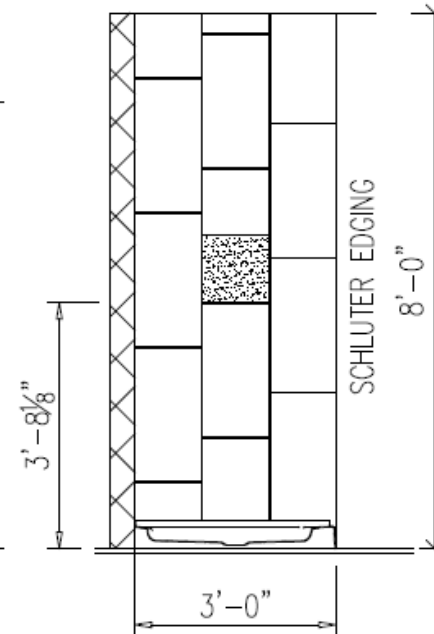

RIGHT WALL

IRON CRAFT 12X24(VERTICAL) WALL TILE (STAGGERED 33%) w/ 12X12 NICHE (HATCHED TO DISTINGUISHED LOCATION) 12" WIDE ACCENT TILE (VERTICAL), RANDOM PATTERN 1/16" GROUT SPACE, SCHLUTER TRIN ON SIDED

TILE SHOWER OPTIONS

IRONCRAFT 60" HORIZONTAL TILE SHOWER

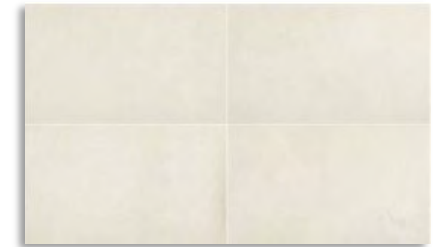
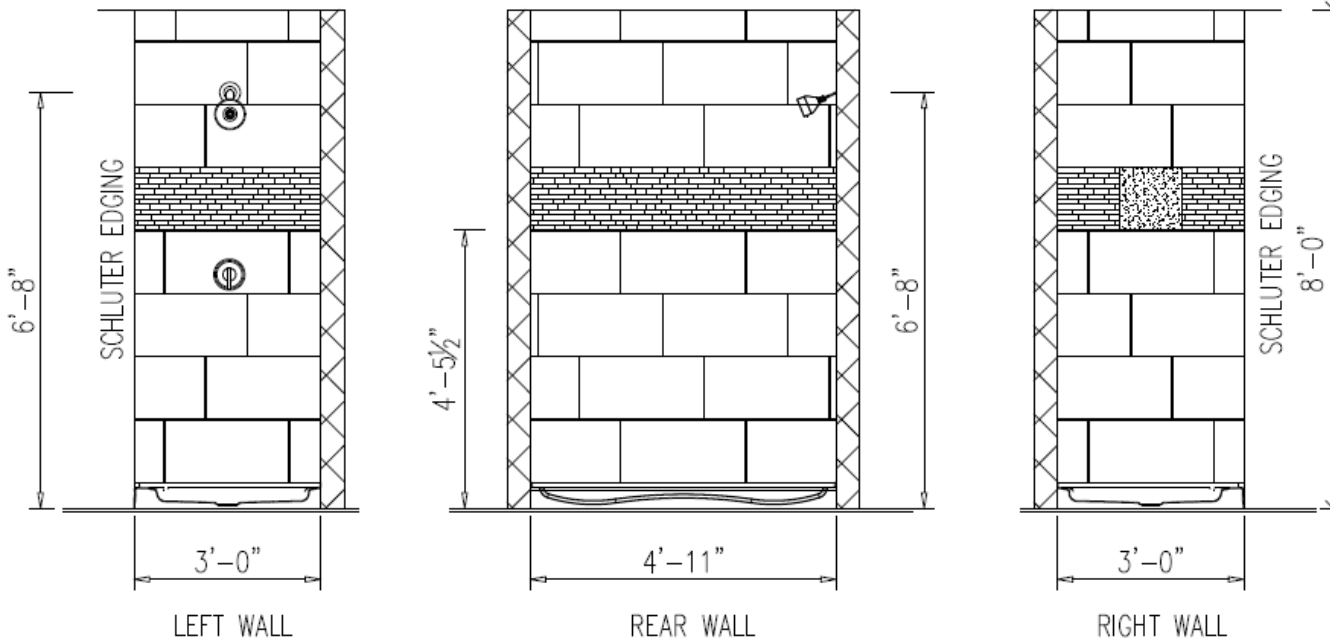

IC11— PHOSPHER WHITE
Grout: 382 Bone

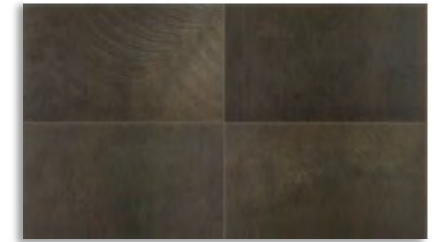

IC15—SABLE BLACK
Grout: 165 Delorean Gray

IRON CRAFT 12X24(HORIZONTAL) WALL TILE (STAGGERED 33%) w/ 12X12 NICHE (HATCHED TO DISTINGUISHED LOCATION)
12" WIDE ACCENT TILE (VERTICAL), RANDON PATTERN 1/16" GROUT SPACE, SCHLUTER TRIN ON SIDED

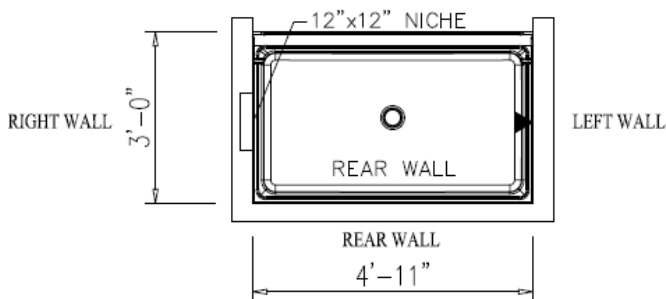

IC17—GREY BLACK

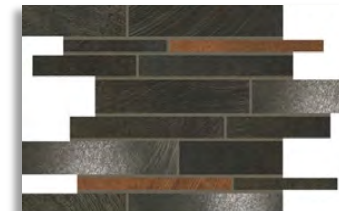

IC18—SABLE BRONZE

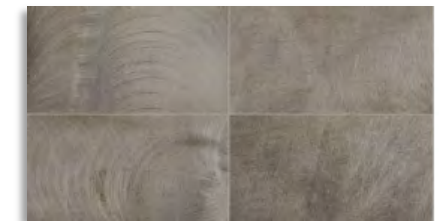

IC13—CHARCOAL GREY
Grout: Winter Gray

Final selection should be made by physical samples

TILE SHOWER OPTIONS

WALK-IN SUBWAY TILE SHOWER



Artic White Tile with Upgraded Faucets

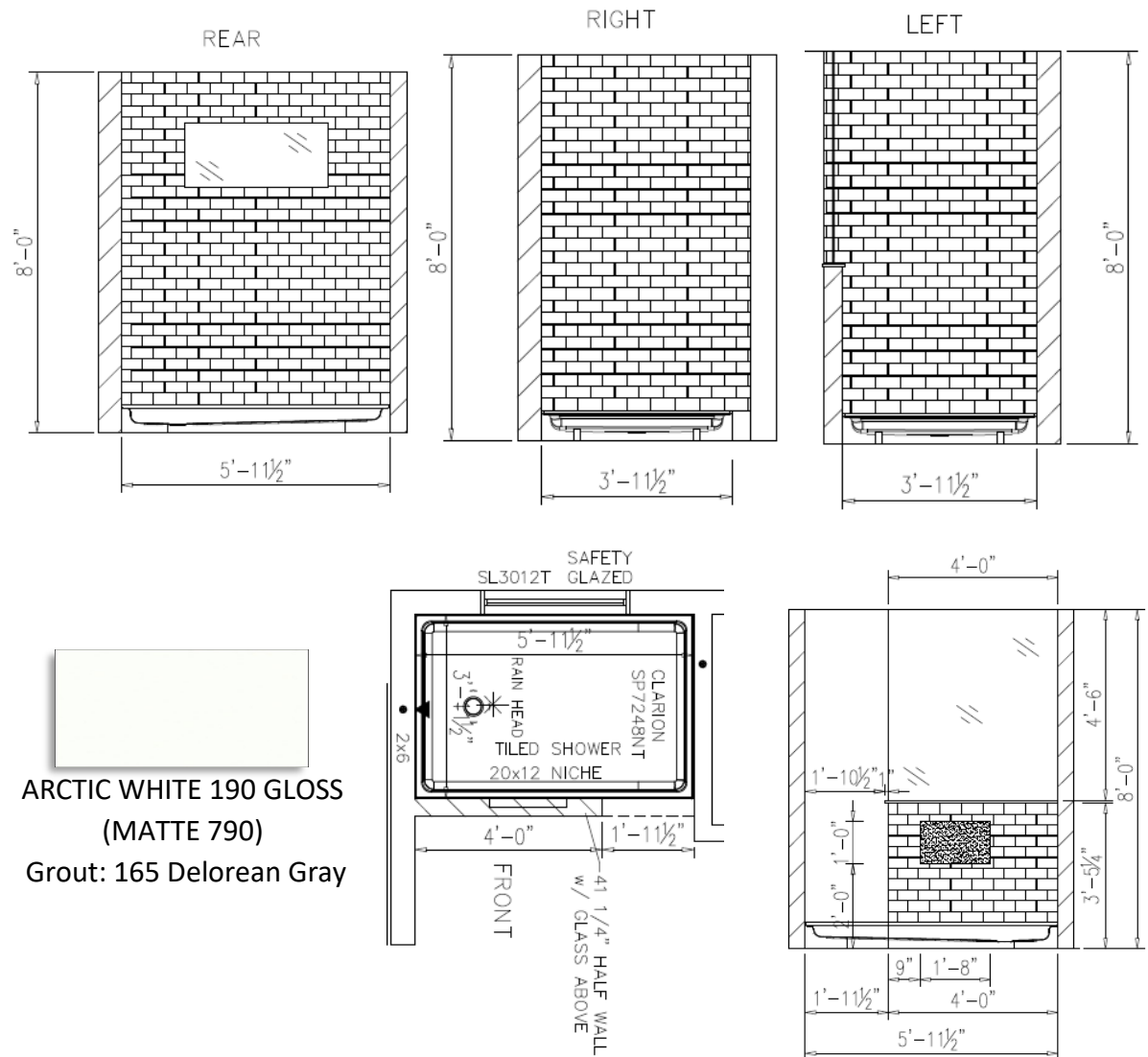

TILE SHOWER OPTIONS

SUBWAY TILE SHOWER OPT 1

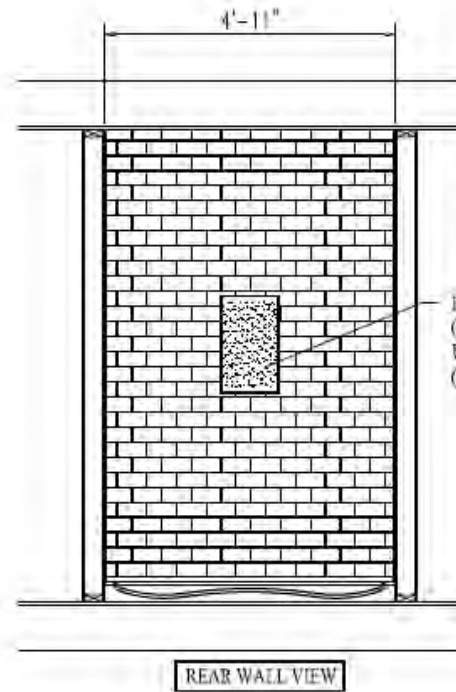
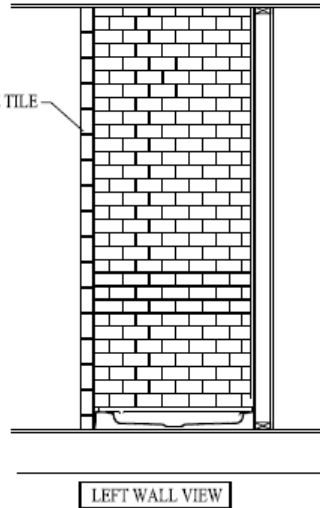
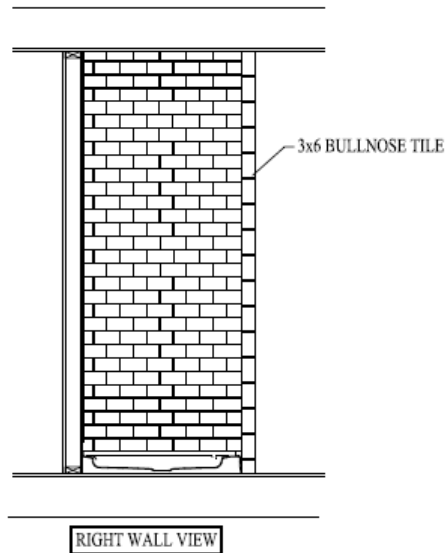

COLORWHEEL WHITE 3x6 WALL TILE
PATTERN: BRICK (50% OFFSET)
w/ 1/16" GROUT LINE
GROUT: Delorean Gray

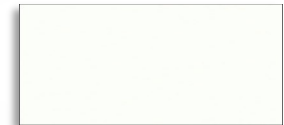

ARCTIC WHITE 190 GLOSS
(MATTE 790)
Grout: 165 Delorean Gray

Pattern: Brick (50% offset) w/ 1/16" Grout Line (Delorean Gray)

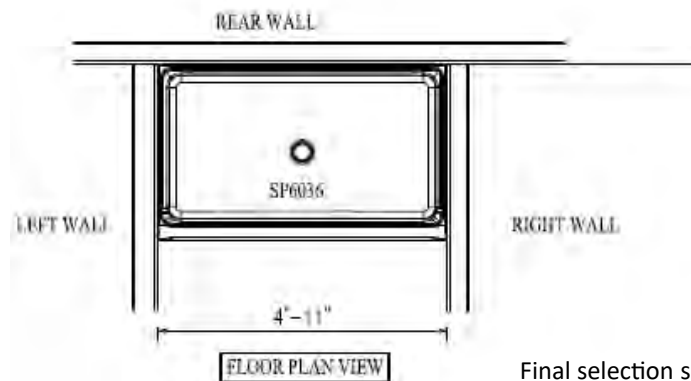

Final selection should be made by physical samples

TILE SHOWER OPTIONS

SUBWAY TILE SHOWER OPT 2



ARCTIC WHITE 190 GLOSS
(MATTE 790)
Grout: 165 Delorean Gray



2X4 FLORENTINE—CARRARA
Grout: 165 Delorean Gray

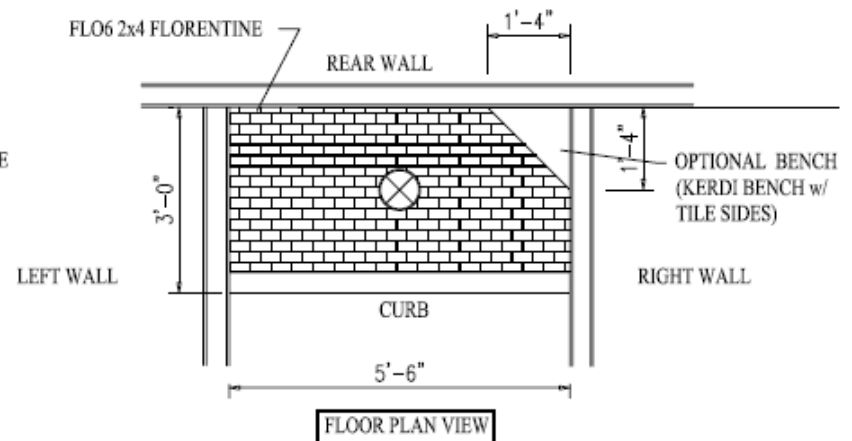
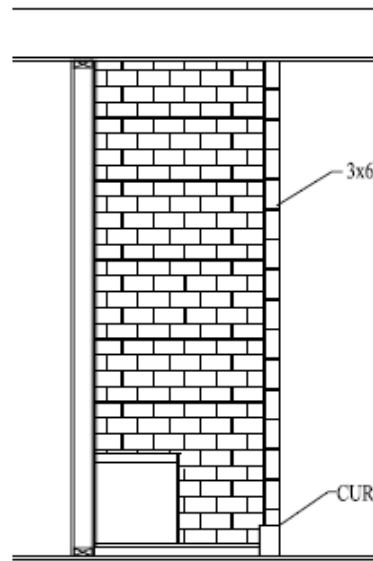

OPTIONS: CORIAN BENCH - GLACIER WHITE CORIAN TOP
CARRARA MARBLE CURB
CARRARA MARBLE CURB & BENCH

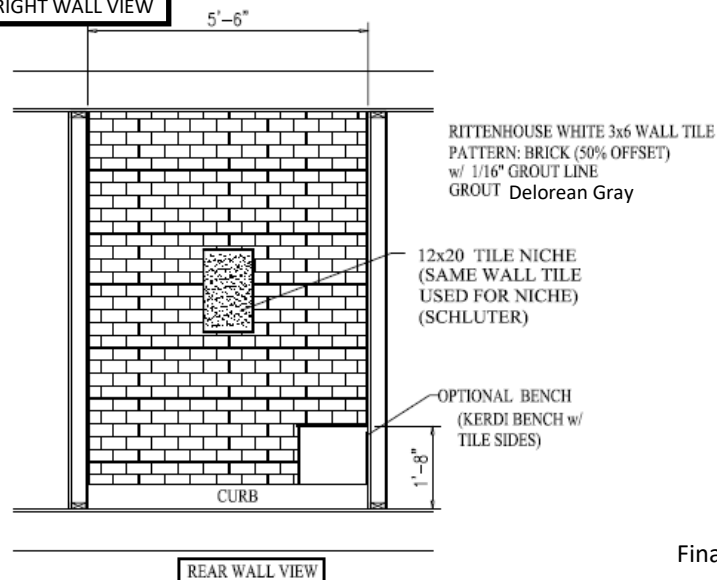
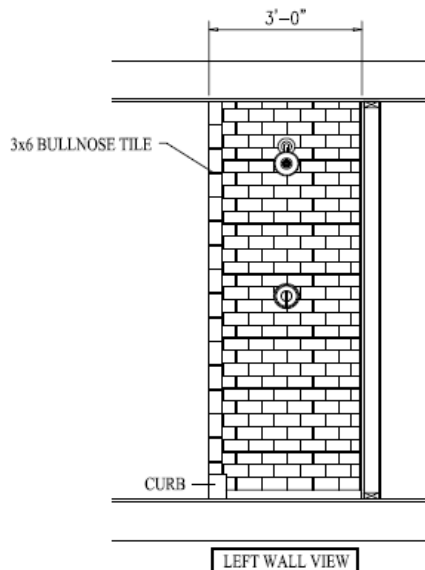

OPTION 2

Final selection should be made by physical samples

STANDARD GROUT OPTIONS



#540 Truffle



#19 Pewter



#335 Winter Gray



#165 Delorean Gray



#386 Oyster Gray



#145 Light Smoke



#122 Linen



#172 Urban Putty



#382 Bone



#381 Bright White

TILE PATTERN TERMINOLOGY

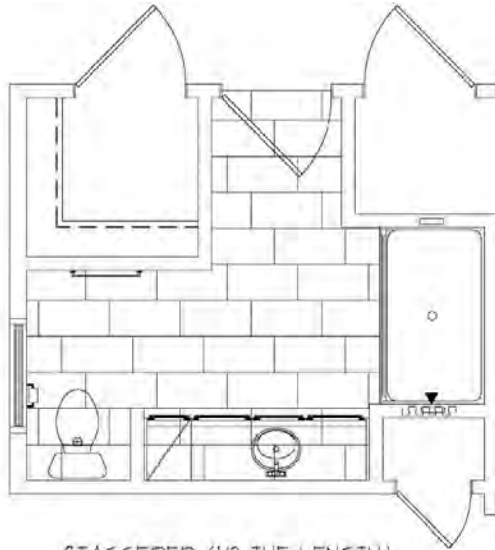

STAGGERED (1/3 THE LENGTH)
(12x24 TILE SHOWN)

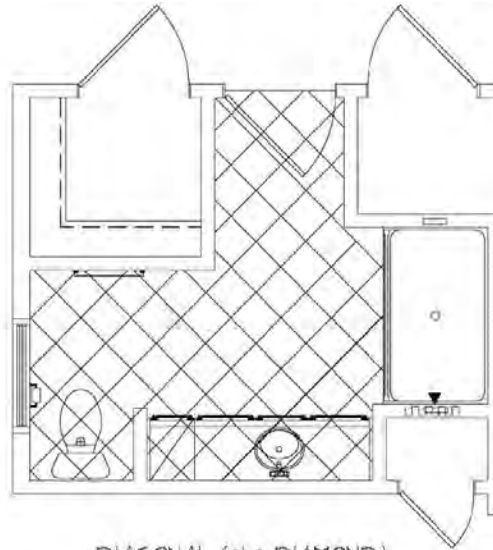

DIAGONAL (aka DIAMOND)
(12x12 TILE SHOWN)

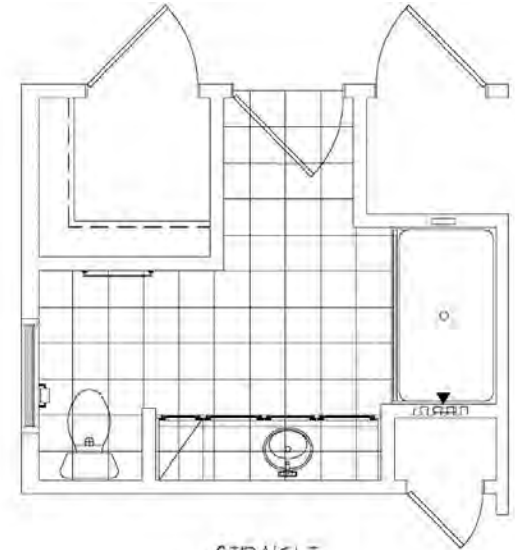

STRAIGHT
(12x12 TILE SHOWN)

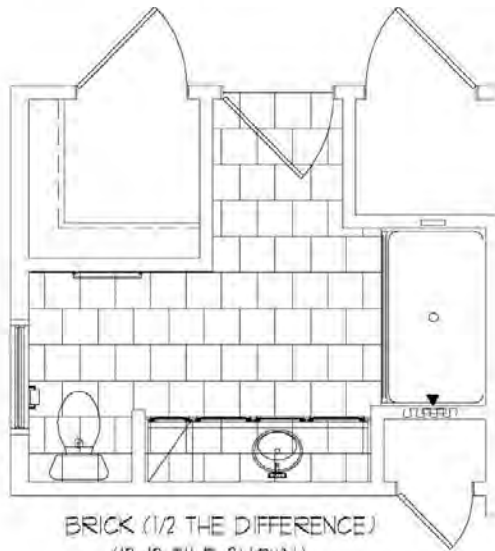

BRICK (1/2 THE DIFFERENCE)
(12x12 TILE SHOWN)

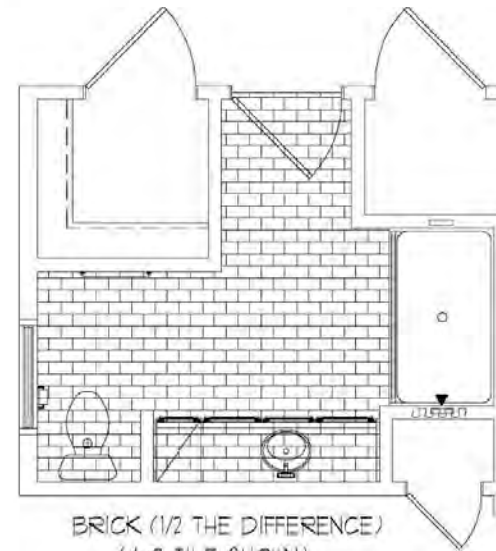

BRICK (1/2 THE DIFFERENCE)
(4x8 TILE SHOWN)